

# Kendo Equipment Manual



(Please don't illegally copy this book)

# Table of Contents

## Introduction

To do kendo safely.....	2
-------------------------	---

## 1 . The shinai 竹刀

1-1 . The construction of the shinai (weights and lengths) .....	5
How to keep your shinai safe.....	6
About the shinai .....	6
1-2 . Disassembly of the shinai.....	8
1-3 . Maintenance of the shinai.....	9
1-4 . Making a shinai out of used parts.....	10
1-5 . Fixing the shinai tip.....	11
1-6 . Tying the shinai handle.....	12
1-7 . Tying the nakayui `thong'.....	15
1-8 . Tuba and tubadome.....	16
1-9 . How to carry the shinai.....	16
Comparing the shinai and bokutou with a katana.....	17

## 2 . The Kendogi ‘ jacket ’ 剣道衣

2-1 . The construction of the kendogi .....	18
Why are the jackets and trousers made of cotton dyed with indigo? ...	18
2-2 . How to wear the kendogi.....	19
2-3 . How to wash the kendogi.....	19
2-4 . How to fold the kendogi.....	20

## 3 . The Hakama ‘ trousers ’ 袴

3-1 . The construction of the hakama.....	21
About the hakama.....	21
3-2 . How to wear the hakama.....	22
3-3 . How to fold and stow the hakama.....	23
3-4 . How to wash the hakama.....	24

## 4 • The tare ‘ waist armor ’ 垂

4-1 . The construction of the tare.....	25
The nafuda ‘name sack’.....	25
4-2 . How to wear the tare .....	26
4-3 . How to keep your tare well.....	26

## 5 . The do ‘breastplate’ 胴

5-1 . The construction of the do.....	27
The shokkou.....	28
5-2 . Putting on the do.....	29
5-3 . How to tie the cords – method A ~ D.....	33
5-4 . How to keep your do well .....	33

## 6 . The men ‘helmet’ 面

6-1 . The construction of the men .....	34
How to connect the men chikawa.....	35
How to make the men.....	35
6-2 . Putting on the tenugui ‘men towel’ – Method A ~ C.....	36
6-3 . Putting on the men- Method A • B.....	39
6-4 . How to keep your men.....	41
Adjusting the lengths of the men cords.....	41

## 7 . The kote ‘gauntlets’

7-1 . The construction of the kote.....	42
7-2 . Putting on the kote.....	43
7-3 . Taking off the kote.....	44
7-4 . How to keep your kote well .....	44
7-5 . Tying the kote cords.....	44

## 8 . The equipment bag

8-1 . The construction of the equipment bag.....	47
8-2 . Putting the gear in.....	47
8-3 . Taking the gear out.....	47
Hanging up your gear.....	48

9 . Glossary.....	49
-------------------	----

In conclusion .....	51
---------------------	----

# Introduction

## To do kendo safely

We have written an easy to understand, illustrated manual to help kendo players can maintain their own equipment.

When you strike with the "shinai", it should look like this:

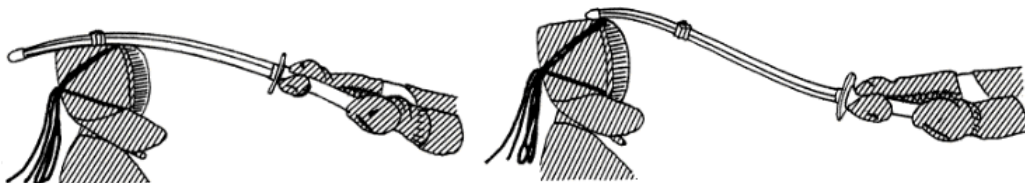

But if your shinai was broken,



But if your shinai has a loose cord,

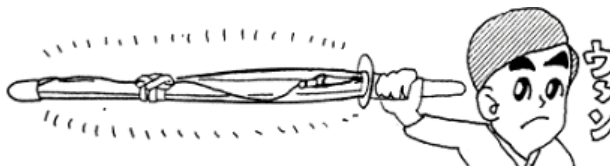

or out of place nakayui, or a loose nakayui

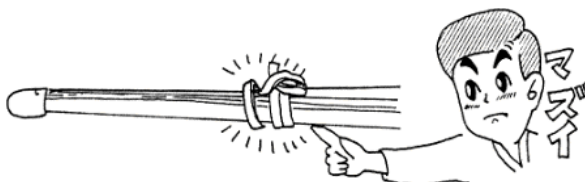

the leather tip may come off the end and the bamboo slats poke someone's eye. People have been blinded like this.



Please read this manual and safely maintain

your shinai and armor.

# 1 . The shinai 竹刀

## 1 - 1 . The construction of the shinai

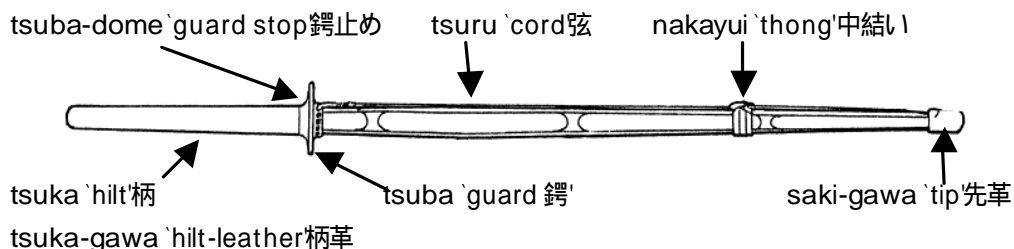

4 shaku (121 cm) length of bamboo is cut 10 cm from the roots. It is then split vertically into 6-8 slats, which will be used to make different length shinai depending on their weight. Four slats with matching joints are chosen and then heated and bent into shape before finally being sanded down to make a single shinai. It is rare for all four slats to come from the same piece of bamboo.

When you chose your shinai , you think about not only length and weight but also balance and types (fat form , fat form , etc. variously :). next,; tsuka-gawa and nakayui and the others.

There are two kinds of leather which is made of these small articles. One is.gintuki leather , this is stronger than the other( toko leather).The gintuki leather has skin's surface.. You would chose gintuki leather.

### Shinai weights and lengths

( see: JKF "Kendo tournaments and judging rules" This is changed on April 1, 1999. )

Length and weight are of a fully constructed shinai, not including the tsuba.  
 is minimum diameter of saki-gawa (The unit:cm).

	Sex	Primary School		Junior High School	High School	Adult · Uni-student			
		When using one swords (ittou)						using two swords (ni-tou)	
							the longer	the shorter	
Length	Both	<=99	<=105	<=111	<=114	<=117	<=120	<=114	<=62
Weight	Male	No limit	>=280 g	>=370 g	>=440 g	>=480 g	>=510 g	>=440 g	280 ~ 300
	Female	>=260 g			>=400 g	>=420 g	>=440 g	>=400 g	250 ~ 280
saki-gawa	Male				25	26	26	25	24
	Female				24	25	25	24	24
Nick-name		sabuni 3 "shaku" 2 "sun"	Sabuyon 3 "shaku" 4 "sun"	saburoku 3 "shaku" 6 "sun"	sannana 3 "shaku" 7 "sun"	sanpachi 3 "shaku" 8 "sun"	sanku 3 "shaku" 9 "sun"	sannana 3 "shaku" 7 "sun"	

Note 1: the JKF places no restrictions on weight for primary school students.

Note 2:shaku and sun are old Japanese units, 1 sun = 3.03 cm; 1 shaku = 10 sun.

You must keep your shinai safe !

So after playing KENDO, you must check and maintain your shinai.

To do kendo safely, it is important that your shinai and armor are kept in good condition through regular maintenance. Unless the kendo player (or the parents of young children) understand how the equipment is constructed and how to look after it, it can be dangerous. You need to be careful so that your opponent won't be injured, for example by splinters entering the men or piercing your opponents arm. People have lost their sight and even their life when a cracked piece of bamboo pierced their eyes. People who don't care to look after their shinais but instead treat them with chemicals or use carbon fiber shinais won't develop this spirit. All you need to do is start off with a well shaped shinai and look after it carefully. Instead of checking the diameter you should instead continually check for splinters and splits.

Small Knoeleges

## About the shinai

Two kinds of shinai's bamboo materials

Most of the shinais sold are made of keichiku, a variety of bamboo that grows in warm areas. Bamboo with a diameter of 7-8 cm is harvested throughout the year. Its fibers are more dense and stiff, on the other hand its stiffness means it breaks more easily than madake. In addition, because it may be heated and then rapidly dried at customs inspections it loses its natural moisture and oil which makes it even more likely to split. It is cheaper than Madake bamboo . It grown in regions with large temperature variations in the seasons is denser and more flexible than keichiku bamboo. Four year old bamboo with a diameter of 8-12 cm is harvested from October to February. This bamboo may splinter but does not split easily. Mosochiku (the largest kind of bamboo) looks strong but is inflexible so is not used for making shinais.

When you strike your shinai only once, the bamboo will unfortunately break. So, you should cut the edge of the bamboo, and paint the row, the Vaseline.

And you must remark " Old bamboo is fragile, you must not use " .

## A limit on the diameter of a shinai

JKF put out the guidance indicator for the accident prevention with the bamboo sword on November 10, 1998. The position of nakayui is 1/4 of the total lengths of the bamboo sword the sword ahead, lengths of sakigawa is 50 millimeters or more. "Minimum diameter" of sakigawa (not length with the needlework fee but side which was able to be measured small) was ruled on April 1, 1999.

Shinai gauge was made by all-Japan budogu federation. It is made of plastic, can measure the standard thickness of the shinai. We have three shinai gauges, 24milli (for male under 3.6 and female under 3.7), 25milli (for male 3.7, female 3.8-3.9), 26milli (for male 3.8-3.9).

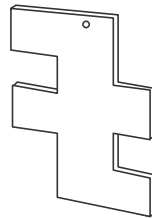
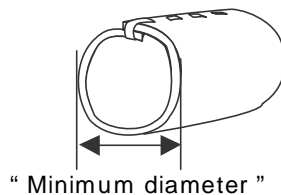

Shinai gauge

## What makes a good "shinai"?

The most important thing is that it is both strong and flexible. If you put the tip of a shinai on the floor and try to bend it, then it should bend about a third of the way from the tip (around the nakayui), at the place you use to strike your opponent. You should be able to feel it pushing back.

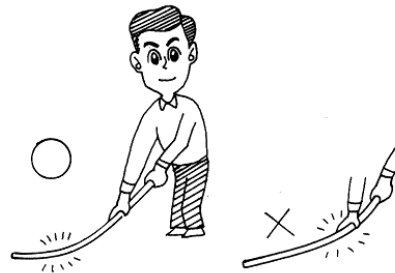

A weak shinai will bend around the guard ("tsuba"). The point at which the shinai bends is the point where it releases power when you strike. When you strike with a weak shina" it will bend like a stick from the tsuba to the tip and then whip back more powerfully than the armor can protect. It can also pierce the "men"-grill and hurt your opponent and may cause you to hurt your own wrists and elbows. Weak shinais have the following characteristics: (1) they bend at the tsuba; (2) they are often planed down to make the handle thin enough; (3) they are often thin at the tip, thick in the middle, and then thin again at the hilt; (4) they tend to be made of less dense bamboo.

Maintaining your shinai while you use it builds up 'samurai spirit' and makes you fully appreciate bamboo.

Bamboo splits and splinters while it is used so requires maintenance.

# 1 - 2 . Disassembly of the shinai

Loosen or untie the nakayui 'leather thong'.



Untie the tsuru 'cord'.

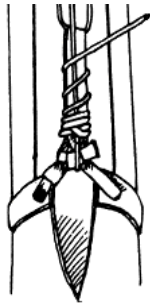

Pull the leather tip (saki-gawa) off with one hand, while holding the bamboo slats together with the other to keep the rubber tip (saki-gomu 先ゴム) in place.

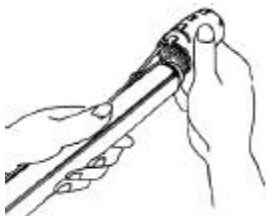

Take off the leather hilt (tsuka-gawa).

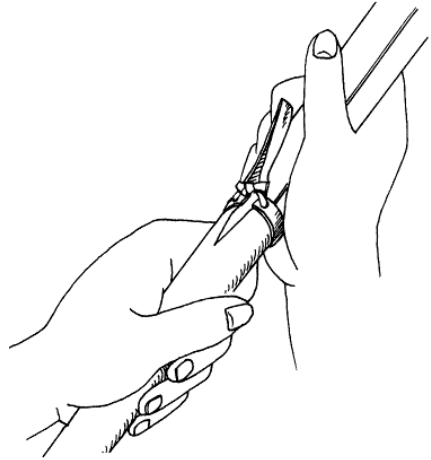

Your shinai should now look like this: (Normally you only need to completely disassemble the shinai to smooth or replace a whole slat.)

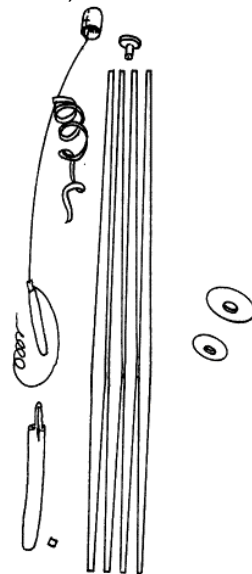



## 1 - 3 . Maintenance of the shinai Removing splinters

When you have some splinters or a small split, take off the nakayui, tsuru and tip as described in section (you may have to completely disassemble the shinai).



Scrape the splinters off with firm strokes from the hilt towards the tip, using a knife, file or a piece of glass. If you scrape from tip to hilt, the blade may dig into the bamboo.

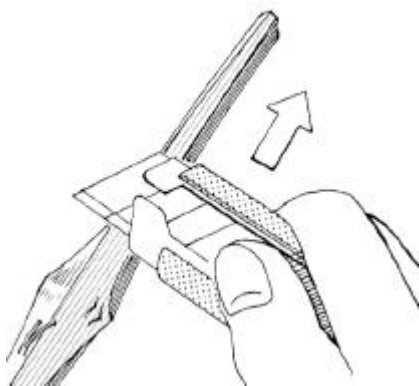

Next use some sandpaper to smooth the surface. Finally rub in a little wax, Vaseline or vegetable oil.

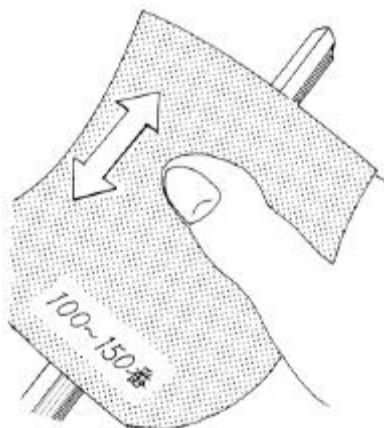

Note: If the bamboo actually splits (with or against the grain) you should stop using it. It is dangerous to tape it up and keep using it.

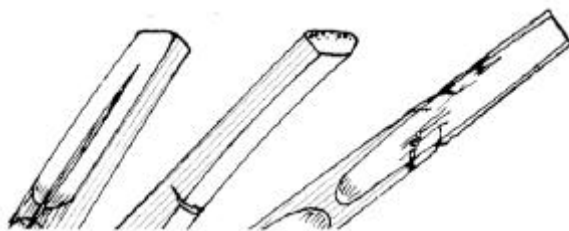

# 1 - 4 . Making a shinai out of used parts

Combining slats from several damaged shinais to make a new one.

Shinai have a small iron plate (called a chigiri) in the handle that keeps the handle together and stops the slats from moving around. It fits into a groove cut in each slat.

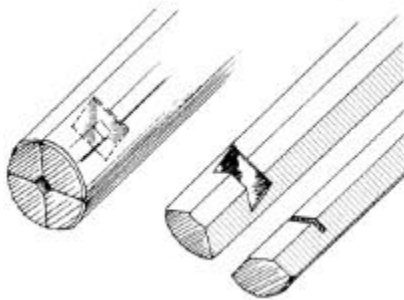

Therefore it is necessary to cut a new set of grooves. Leave the iron plate in the slats it fits then add the new slats and squeeze tightly. The plate should leave a little mark.

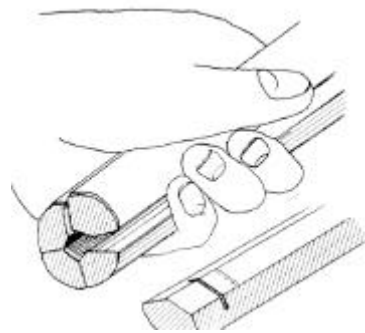

When you use slats from different shinai, the grooves may be in different positions.

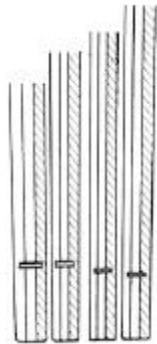

Use a small saw (a hacksaw is fine) to cut a thin groove along this mark.

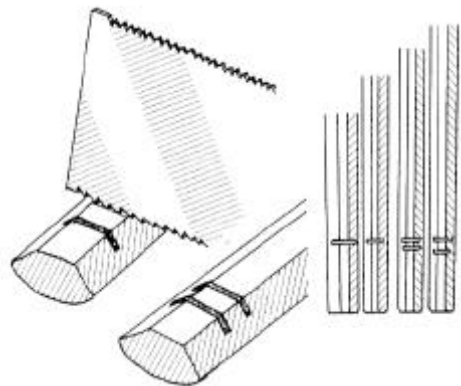

# 1 - 5 . Fixing the *shinai* tip 先革

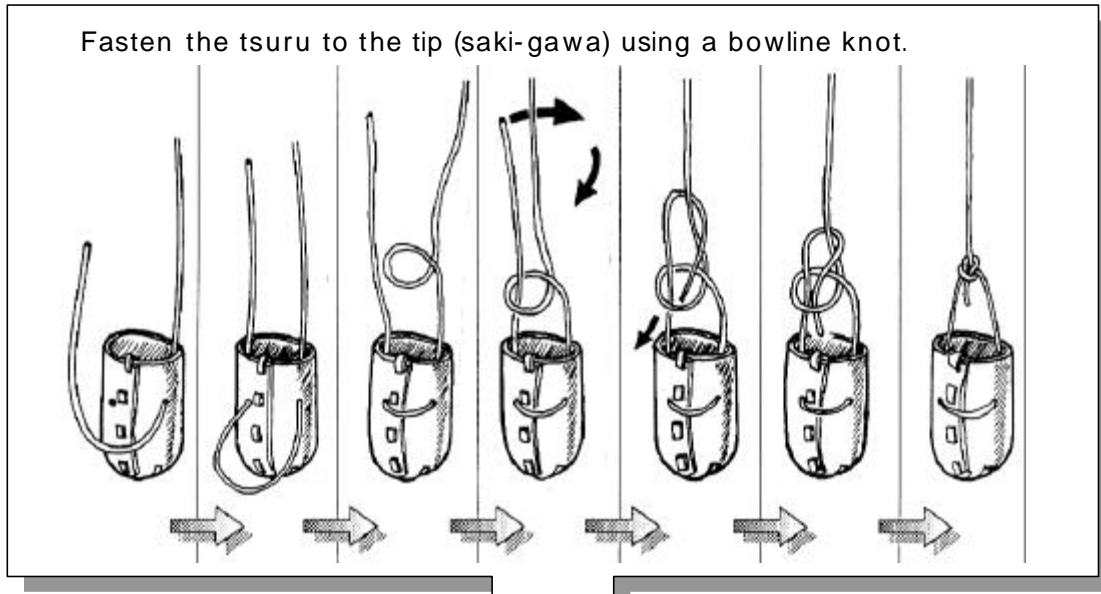

Put the rubber tip ("saki-gomu") in the end. Various diameters of rubber tip are sold, you should use one that just fits in the space left by the bamboo, if it is too small it can be dangerous. Carbon-fiber shinai's have a special kind of rubber tip (actually plastic) which should always be used with them.

Slide the leather tip on.

The construction of the saki-gawa

The saki-gawa 'leather tip': If the end opens or is holed, get a new one, it cannot safely be repaired.

# 1 - 6 . Tsuru: Tying the shinai handle 弦

tsuru is a bowstring made of a chemical fiber or a silk. Fiber. Silk one needs drawing through to soften by a eyeleter before tying.

First put the hilt leather (tsuka-gawa) on.  
(If the shinai is new it will be held together with string. Take this string off.)



Using a rubber sheet (or gloves) makes it easy!

Pass the cord through the nakayui 'leather thong' (that holds the slats together) and komono 'small leather loop'.

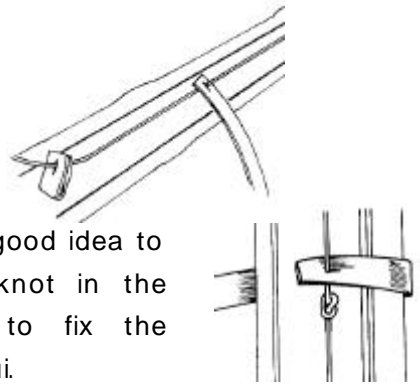

It is a good idea to tie a knot in the tsuru to fix the nakayui.

## How to tie the leather cord

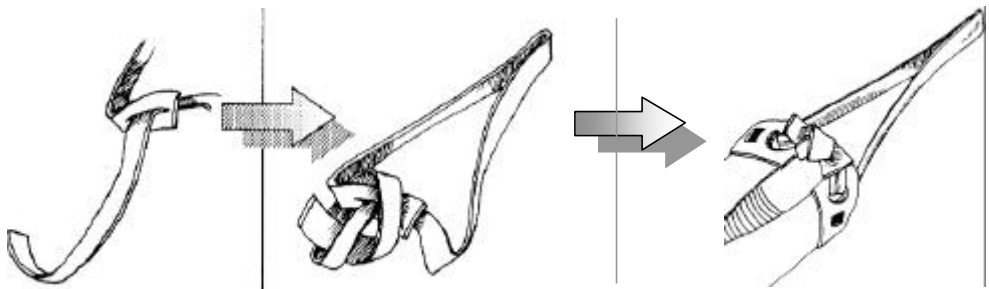

## The construction of the tsuka and to shorten

The hilt (tsuka): Pucker the pommel (tsuka-gashira) and sew it as shown below, then turn it inside out.



To shorten the hilt, cut the end or closest to the guard or cut the other side and do like written in the left.

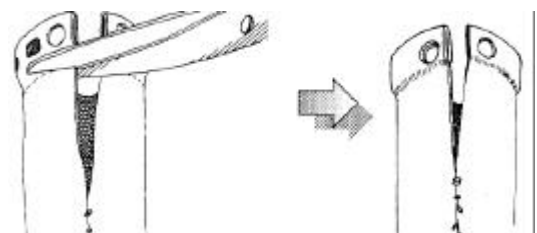

Tie the cord securely round the komono. There are three ways.

A

Through the tsuru  
to the hole of small  
articles



to round in  
surroundings of small  
articles



passes as shown in  
figure



trough edge of  
tuka's frap, return  
to small articles,



B (琴弦はこの方法で)

Through the tsuru  
to the slit of small  
articles



to round in  
surroundings of small  
articles



passes as shown in  
figure



trough edge of  
tuka's frap, return  
to small articles,

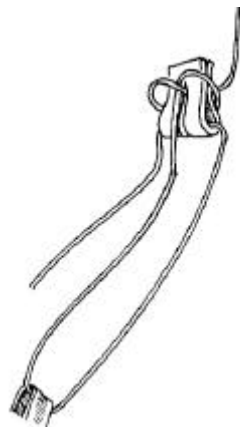

C

Make a circle and



tying



trough edge of  
tuka's frap, return  
to small articles,



Pass the cord through the 'leather loop' on the hilt (kawa-himo); Thread it back through the komono. Pass it under the knot in the hilt's leather loop and pull it tight. Pull the cord taught with your right hand while you hold the komono down with the left.

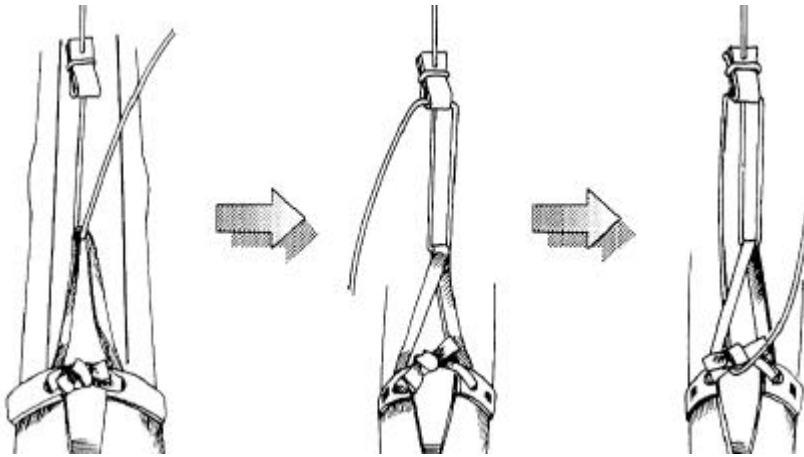

Wrap it round the loop. Tie it once.

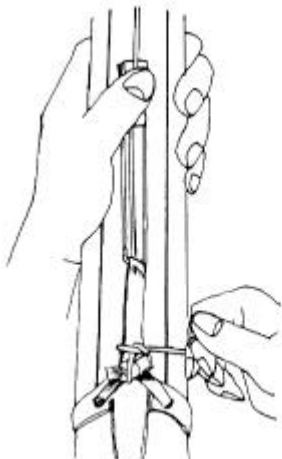
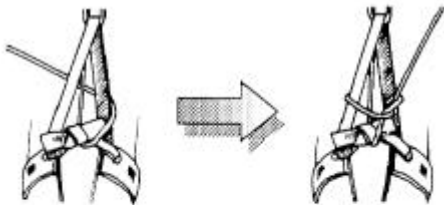

Wrap the cord round the leather loop about seven times.



Finally, use an awl to make a space between the two branches of the loop and pass the cord through.

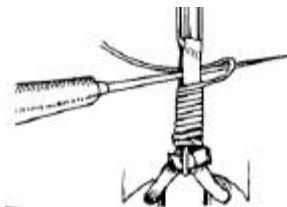

The final version!

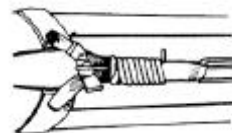

# 1 - 7 . Tying the nakayui 'thong' 中結い

Wrap the nakayui 'thong' thrice round the shinai rough side up.

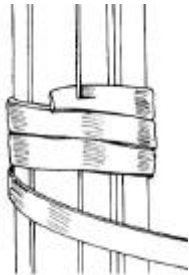

Thread it under the cord and cross it back.

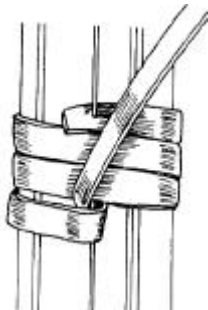

Thread under the tsuru from the other side.

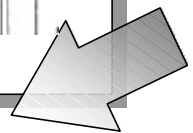

Loop it round and under the last loop.



Again loop it round the tsuru, cross over and pass it under the last loop.



Repeat this once more, then cut off any excess leather.



左右に締まることで、動かなくなります。

What should I do for emergency repairs if the nakayui breaks?

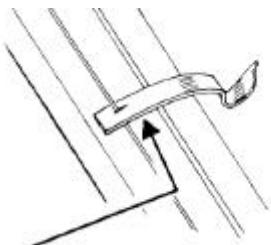

Cut the hole open and take it off.

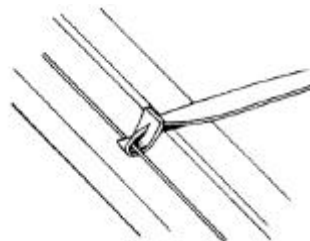

Then make a new hole, attach it as shown and start again.